

# PILOT OPERATED SOLENOID VALVE CEME 2/2 ESM 86 NC

## MAIN CHARACTERISTICS

The ESM 86 solenoid valve is a 2/2 piloted valve dedicated to the shut off of clean and non-aggressive fluids. The operation way is normally closed. The standard construction includes quality brass body and cover, internal parts in stainless steel and diaphragm is NBR. This solenoid valve is also available with several diaphragm materials and various coil voltages. The ESM 86 W version 1/2 ", 3/4 " and 1 " have the French homologation ACS for the drinking water.



## AVAILABLE MODELS

ESM86 : G 3/8" to G 3"

ESM86W : G 1/2" to G 1"

Diaphragm : NBR, EPDM et FPM.

Voltages : See on page 3.

BSP Screwed end connections.

## LIMITS OF USE

Electric protection	IP 65		
Max allowed fluid pressure : PS	0 - 10 bar		
Max allowed fluid temperature : TS	NBR	EPDM	FPM
	-5°C / +80°C	-5°C / +110°C	-5°C / +150 °C
Room temperature	-10°C / +80°C		

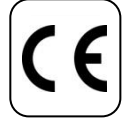

\* In direct current, over 40°C, the maximum differential pressure can be reduced.

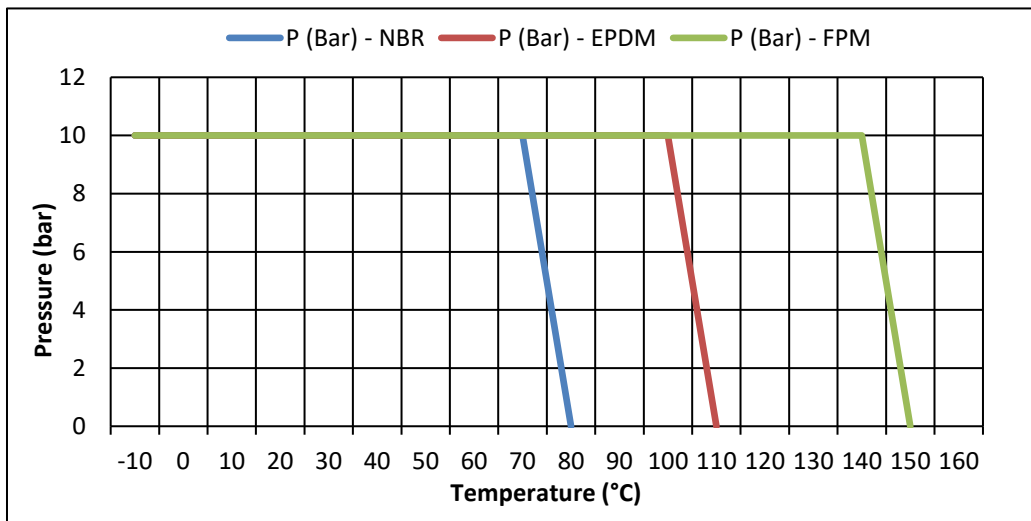

Information given as an indication only, and subject to possible modifications



SECTORIEL S.A.  
45 rue du Ruisseau  
38290 SAINT QUENTIN-FALLAVIER – FRA NCE  
Tél : +33 4 74 94 90 70 - Fax : +33 4 74 94 13 95  
[www.sectoriel.com](http://www.sectoriel.com) / Email : [sectoriel@sectoriel.fr](mailto:sectoriel@sectoriel.fr)

Pages	1/5
Ref.	FT8600 ENG
Rev.	03
Date	05/2023

# PILOT OPERATED SOLENOID VALVE CEME 2/2 ESM 86 NC

## REGULATIONS AND STANDARDS OF CONSTRUCTION

Item	Standard	Item	Standard
Pressure Equipement Directive CE 2014/68	<b>3/8" to 1"</b> : A4 § 3	Brass materials	EN 1503-4
	<b>1"1/4 to 3"</b> : category I		
Low voltage directive CE 2014/35		BSP thread	ISO 228
Connector	DIN 43650	Drinking water (ESM86 W)	<b>1/2"</b> : ACS
			<b>3/4"</b> : ACS
			<b>1"</b> : ACS

## PRESSURE LOSS DIAGRAM (BAR)

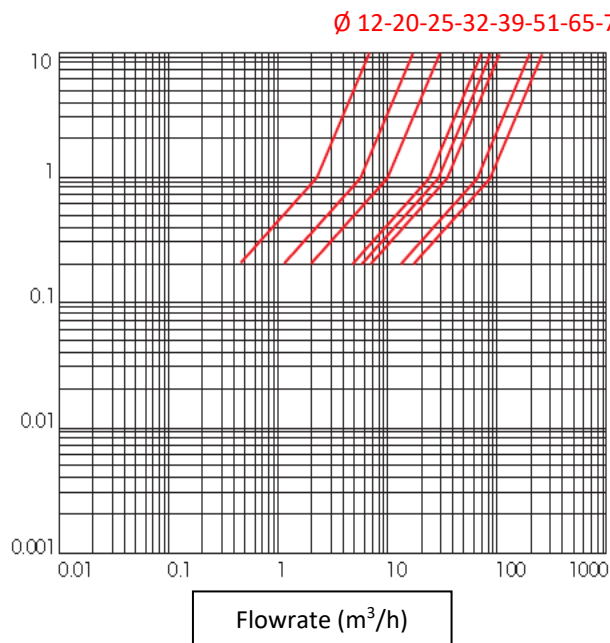

## DIMENSIONS (mm) AND WEIGHT (kg)

DN	A	B	C	D	Weight (Kg)
<b>G 3/8"</b>	61	89	48	77	0,6
<b>G 1/2"</b>	61	89	48	77	0,6
<b>G 3/4"</b>	87	101	69	84	1
<b>G 1"</b>	100	106	80	86	1,2
<b>G 1" 1/4</b>	131	122	112	95	2,8
<b>G 1" 1/2</b>	146	128	128	98	3,5
<b>G 2"</b>	174	145	146	108	4,8
<b>G 2" 1/2</b>	245	180	184	134	11,4
<b>G 3"</b>	250	190	184	139	12

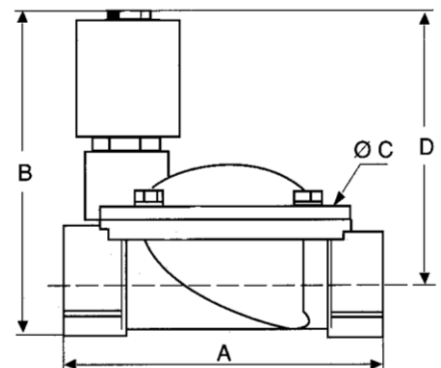

Information given as an indication only, and subject to possible modifications



SECTORIEL S.A.  
 45 rue du Ruisseau  
 38290 SAINT QUENTIN-FALLAVIER – FRA NCE  
 Tél : +33 4 74 94 90 70 - Fax : +33 4 74 94 13 95  
[www.sectriel.com](http://www.sectriel.com) / Email : [sectriel@sectriel.fr](mailto:sectriel@sectriel.fr)

Pages	2/5
Ref.	FT8600 ENG
Rev.	03
Date	05/2023

# PILOT OPERATED SOLENOID VALVE CEME 2/2 ESM 86 NC

## HYDRAULIC CHARACTERISTICS

DN	Port (mm)	Kv (m <sup>3</sup> /h)	Min diff. pressure (bar)	Max diff. pressure (bar)	Coil	Operating time
G 3/8"	10	1,86	0,3	10	B 6	20-60 ms
G 1/2"	12	2,1	0,3	10		
G 3/4"	20	5,7	0,3	10		
G 1"	25	9,6	0,3	10		
G 1" 1/4	32	22	0,3	10		
G 1" 1/2	39	27	0,3	10		50-80 ms
G 2"	51	35	0,3	10		
G 2" 1/2	65	63	0,3	10		
G 3"	75	83	0,3	10		

## ELECTRIC CHARACTERISTICS

Coil classified H. Duty 100%. Connecting by connector T30.

Coil	Current	Available voltages (V)						Frequency		Power consumption	
		12	24	48	110	230	400	50 Hz	60 Hz	Holding	Rush
B 6	AC Coil	12	24	48	110	230	400	50 Hz	60 Hz	11 VA	24 VA
	DC Coil	12	24	48	110					16 W	

## CONSTRUCTION

N°	Item	Material
1	Lock nut	Zincated steel
2	Washer	Zincated steel
3	Coil	PBT + 30% G.F.
4	Tube guide	Stainless steel AISI 430
5	Plunger	Stainless steel AISI 430
6	Spring	Stainless steel AISI 430
7	Support	Stainless steel AISI 303
8	Seal	NBR
9	Spring	Steel
10	Screw	Stainless steel
11	Cover	Brass CW 617 N
12	Spring	Steel
13	Diaphragm	NBR/EPDM/EPDM KTW/FPM
14	Bush	Brass
15	Body	Brass CW 617 N

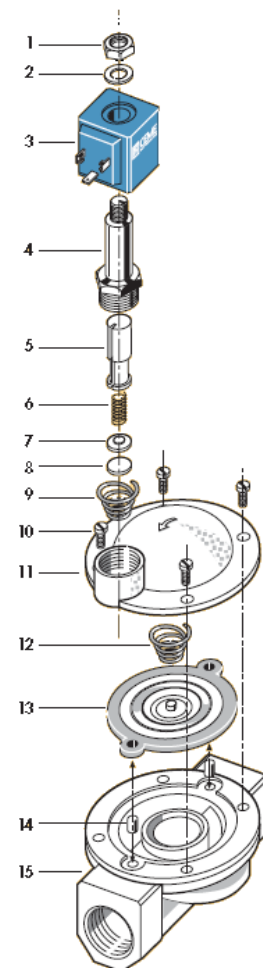

Information given as an indication only, and subject to possible modifications

	SECTORIEL S.A. 45 rue du Ruisseau 38290 SAINT QUENTIN-FALLAVIER – FRA NCE Tél : +33 4 74 94 90 70 - Fax : +33 4 74 94 13 95 <a href="http://www.sectoriel.com">www.sectoriel.com</a> / Email : sectoriel@sectoriel.fr	Pages	3/5
		Ref.	FT8600 ENG
		Rev.	03
		Date	05/2023

# PILOT OPERATED SOLENOID VALVE CEME 2/2 ESM 86 NC

## USE ON DRINKING WATER

The W version of the ESM 86 in diameters 1/2 ", 3/4 " and 1 " can be used on the networks of drinking water. It has the French homologation ACS.

## RISK OF CONDENSATION

In case of use in a wet area or on a network of cooling fluid, there is a risk of condensation between the coil and the pilot-tube. This phenomenon can cause damage to the coil. In this case, plan to use the reinforced sealing kit. Also consult for other alternative solution.

ESM 86	Reinforced sealing kit	980690
--------	------------------------	--------

## RISK OF FREEZING

If the fluid of the network is likely to freeze, intend to provide a heating system adapted to the solenoid valve.

## MOUNTING

Installation in every position except horizontal pipe with coil towards the bottom.  
Respect the sense of flow indicated by the arrow marked on the body.  
For an use on liquids, the installation of a strainer for upstream protection is recommended.

### Check-valve :

A solenoid valve cannot be used as a check-valve. A de-energized normally closed solenoid valve can be crossed by a downstream counterflow. If a both side tightness is required, please add a check-valve downstream of the solenoid valve.

### Example

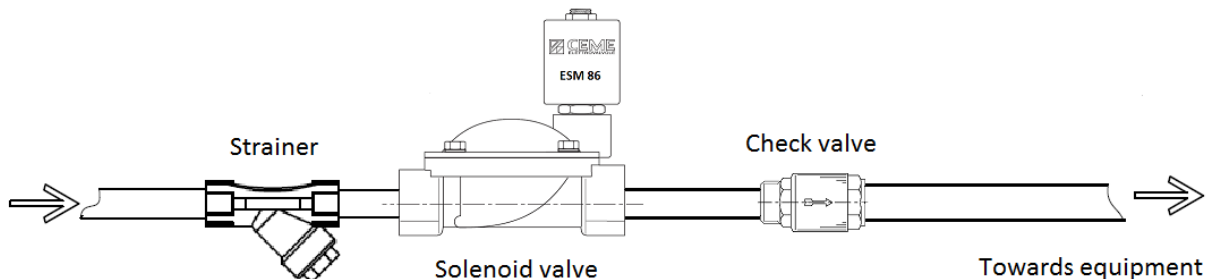

### Scaling :

A solenoid valve used on hard water and kept energized during long period can face scaling problem that can block the operation. For this kind of application, please consult.



Conform also to the assembly instructions supplied with the solenoid valve.

Information given as an indication only, and subject to possible modifications

	SECTORIEL S.A. 45 rue du Ruisseau 38290 SAINT QUENTIN-FALLAVIER – FRA NCE Tél : +33 4 74 94 90 70 - Fax : +33 4 74 94 13 95 <a href="http://www.sectoriel.com">www.sectoriel.com</a> / Email : <a href="mailto:sectoriel@sectoriel.fr">sectoriel@sectoriel.fr</a>	Pages	4/5
		Ref.	FT8600 ENG
		Rev.	03
		Date	05/2023

# PILOT OPERATED SOLENOID VALVE CEME 2/2 ESM 86 NC

## SPARE PARTS

B 6 coil type (Number A)							Connector		
Voltage	230V 50Hz	24V 50Hz	48V 50Hz	110V 50Hz	12V cc	24V cc	T30		
Code	980310	980311	980313	980314	980315	980316	980696		
Voltage	230V 60Hz	24V 60Hz	48V cc	110V cc	12V 50 Hz	380V 50Hz			
Code	980320	980321	980317	980318	980312	980319			
Diaphragm (Number 13)									
DN	3/8"	1/2"	3/4"	1"	1" 1/4	1" 1/2	2"	2" 1/2	3"
NBR	980604		980632	980605	980634	980606	980607	980608	
EPDM	980614		980642	980615	980644	980616	980617		
FPM	980624		980652	980625	980654	980626	980627		
EPDM W		980661	980662	980663					

## CEME TRANSLATIONS REFERENCES

∅ Diameter	3/8"	1/2"	3/4"	1"	1" 1/4	1" 1/2	2"	2" 1/2	3"
CEME	8613	8614	8615	8616	8617	8618	8619	8620	8621
SECTORIEL	See WEB catalog								

Information given as an indication only, and subject to possible modifications

	SECTORIEL S.A. 45 rue du Ruisseau 38290 SAINT QUENTIN-FALLAVIER – FRA NCE Tél : +33 4 74 94 90 70 - Fax : +33 4 74 94 13 95 <a href="http://www.sectoriel.com">www.sectoriel.com</a> / Email : sectoriel@sectoriel.fr	Pages	5/5
		Ref.	FT8600 ENG
		Rev.	03
		Date	05/2023